

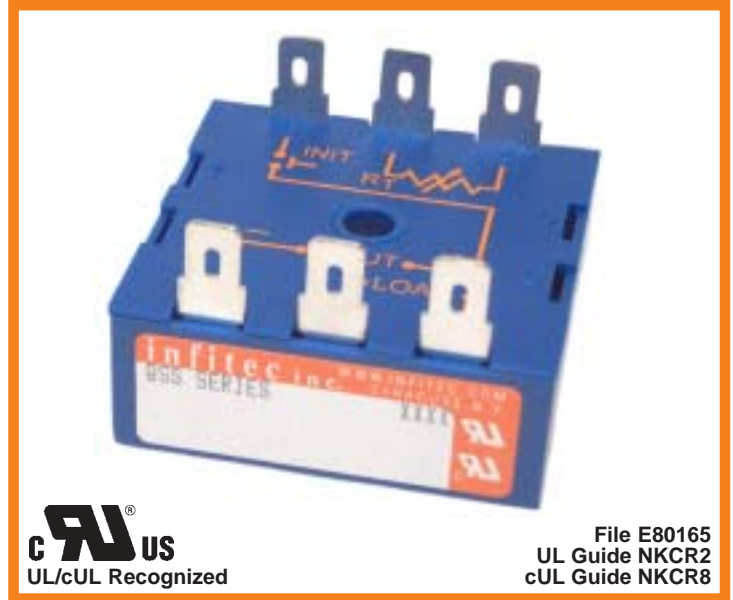

P.O. Box 2956 • Syracuse • New York • 13220
 Phone: (315) 433-1150 Fax: (315) 433-1521
 Toll Free US & Canada (800) 334-0837
 Email: sales@infitec.com

DISCONTINUED SERIES DISCONTINUED SERIES DISCONTINUED

F SERIES DIGITAL ENCAPSULATED TIME DELAY MODULES



File E80165
 UL Guide NKCR2
 cUL Guide NKCR8

FEATURES

- C/MOS Digital Circuitry
- Time Delays To 1000 Minutes
- No First Cycle Effect
- Fully Solid State And Encapsulated
- 0.5% Repeat Accuracy
- Seven Different Modes Of Operation
- Output Rated at 1 Ampere Continuous, 10 Amperes Inrush
- Fixed, Local Or Externally Adjustable Time Delays
- Small Size
- UL/cUL Recognized

SPECIFICATIONS

1. Time Delay.

- 1.1 Type: C/MOS digital circuitry
- 1.2 Range: From 0.05 seconds to 1000 minutes.
Fixed delays available (see time delay chart)
- 1.3 Repeat accuracy: $\pm 0.5\%$ under fixed conditions
- 1.4 Setting accuracy: $\pm 10\%$
- 1.5 Reset time: 50 milliseconds maximum
- 1.6 Recycle time: 100 milliseconds during timing,
50 milliseconds after timing
- 1.7 Time delay vs. voltage and temperature: $\pm 2\%$

2. Input.

- 2.1 Operating voltage: 24, 120 & 230 VAC,
12, 24/28 & 36 VDC
- 2.2 Tolerance: $\pm 20\%$ of nominal
- 2.3 Frequency: 50 - 60 Hertz

3. Output.

- 3.1 Type: Solid state
- 3.2 Form: SPST
- 3.3 Rating: 1 amp steady state, (10 amp inrush, 20 mA. min.)
- 3.4 Life: 100,000,000 operations minimum under full load

4. Protection.

- 4.1 Transient: ± 1500 volts for 150 microseconds
- 4.2 Polarity: DC units are reverse polarity protected
- 4.3 Dielectric breakdown: 1500 volts RMS minimum

5. Mechanical.

- 5.1 Mounting: One #8 or #10 screw
- 5.2 Termination: 1/4" quick connect terminals
- 5.3 Style: Surface mount encapsulated

6. Environmental.

- 6.1 Operating temperature: -20°C to $+80^{\circ}\text{C}$
- 6.2 Storage temperature: -30°C to $+85^{\circ}\text{C}$
- 6.3 Humidity: 95% relative non-condensing

MODE OF OPERATION - SERIES

DELAY ON MAKE - FMS, FMSA

Upon application of power to the input terminals, the time delay begins. At the completion of the pre-selected time delay, the output contact transfers. Reset is accomplished by removal of input power. There is no false output when reset during timing.

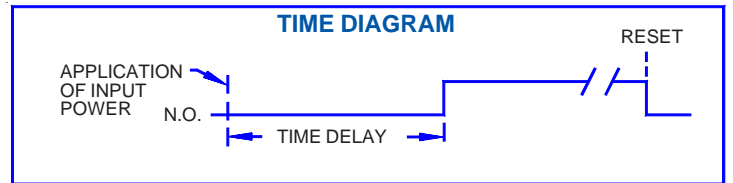

INTERVAL - FIS

Upon application of power to the input terminals, the output contact immediately transfers and the time delay begins. At the completion of the pre-selected time delay, the output contact reverts to its original position. Reset is accomplished by removal of input power.

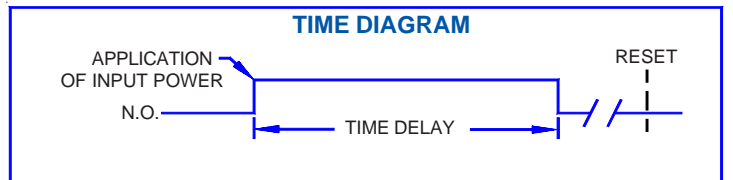

SINGLE SHOT - FSS

Power must be applied to the input at all times prior to and during timing. Upon closure of the initiate switch (momentary or maintained) the output contact transfers and the time delay begins. At the completion of the pre-selected delay period, the output contact reverts to its original position. Removal of input power will reset the control.

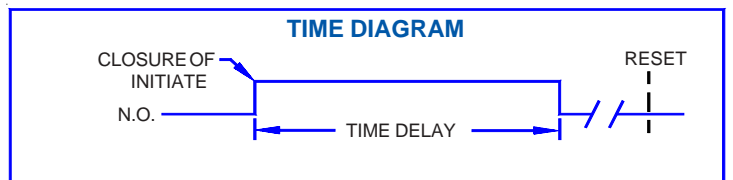

DELAY ON MAKE, NORMALLY CLOSED - FCS

The output is in a normally closed state. Upon application of power to the input terminals, the output contact transfers and the time delay begins. At the completion of the time delay the output contact drops out. Removal of input power from terminal 3 resets the delay and the output contact reverts to its original closed position.

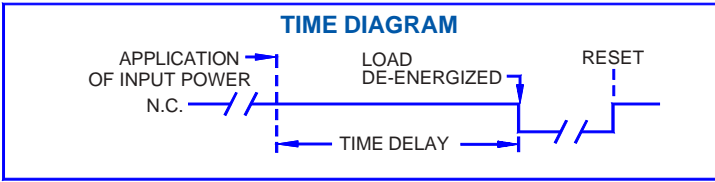

DELAY ON BREAK - FBS

Power must be applied to the input at all times prior to and during timing. Upon closure of the initiate switch, the output contact transfers and remains transferred if no further action is taken. When the initiate switch is opened, the time delay begins. At the completion of the pre-selected delay period the output contact reverts to its original position. Closure of initiate during timing will reset the delay period. Removal of input power will reset the control.

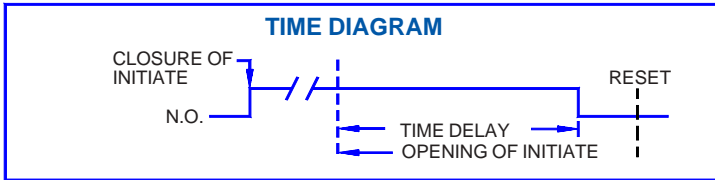

RETRIGGERABLE ONE-SHOT - FOS

Power must be applied to the input at all times prior to and during timing. Upon closure of the initiate switch (momentary or maintained) the output contact transfers and the time delay begins. At the completion of the pre-selected delay period, the output contact reverts to its original position. **NOTE:** Momentary or maintained closure of initiate switch during timing will reset the time delay.

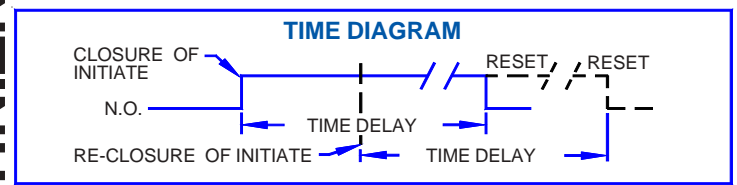

DIMENSIONS

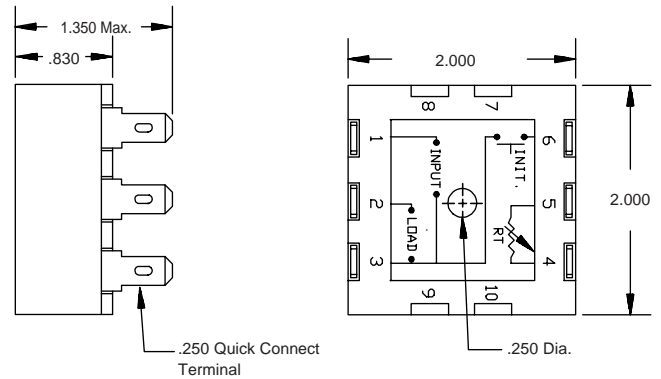

CONNECTION DIAGRAMS

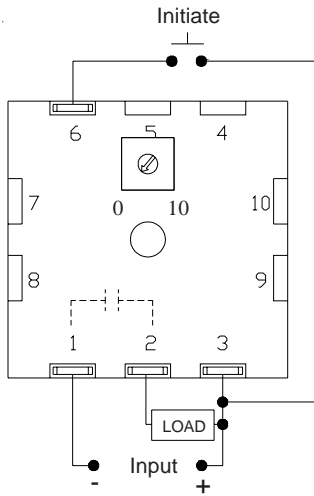

FBS/FOS/FSS
(Local Adjustment Shown)

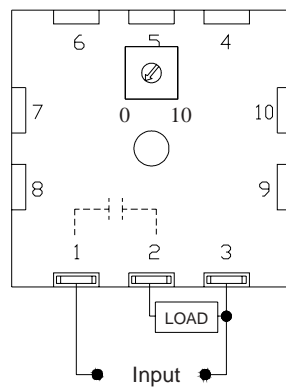

FIS/FMSA
(Local Adjustment Shown)

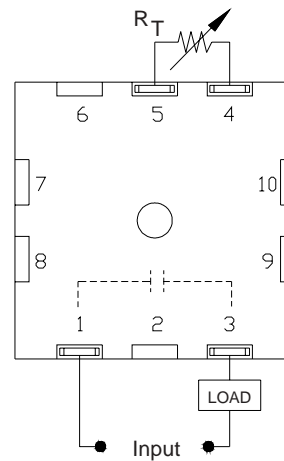

FMS
(External Adjustment Shown)

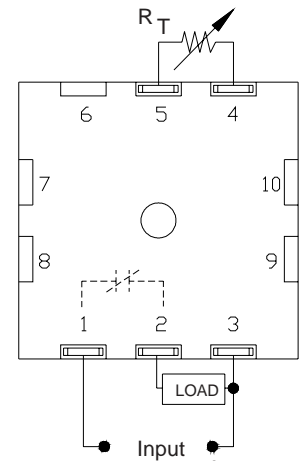

FCS
(External Adjustment Shown)

ORDERING INFORMATION

SERIES	INPUT VOLTAGE	ADJUSTMENT	TIME DELAY RANGE
FBS	1 - 12 VDC	1 - Fixed	See Time Delay Range Chart
FCS	2 - 24/28 VDC		
FIS	4 - 24 VAC		
FMS	5 - 120 VAC		
FMSA	6 - 230 VAC		
FOS	9 - 36 VDC		
FSS			

DISCONTINUED SERIES DISCONTINUED SERIES DISCONTINUED SERIES DISCONTINUED